

DESCRIPTION

With the ingenious mechanics, Linea 1 bring a new picture to display lighting solutions for pendant, recessed and surface mounted system. The system can add different kind of the lighting module you want and offering a harmonious visual expert experience.

GENERAL INFORMATION

- Construction: Aluminum/ Spray powder
- Electrical: 120V
- Dimming: 0-10V
- Recessed, Pendant and Surface mount options
- Color: Black/ White

CHARACTERISTIC

- Modularization and diversity connectors are designed for easy connecting diversity tracks and help to maximize creativity in linear style.
- Track is designed to hide both module & linear driver for elegant appearance.
- Applicable with 18AWG power cable, 120VAC/5A

TRACK SECTION

Article Number	L(mm)	TYPE
LN1-RT-4-(B/W)	44.57"(1132mm)	Recessed with Trim
LN1-RT-8-(B/W)	89.13"(2264mm)	Recessed with Trim
LN1-RTL-(B/W)	44.57"(1132mm)	Recessed Trimless
LN1-RTL-8 (B/W)	89.13"(2264mm)	Recessed Trimless
LN1-SF-4-(B/W)	44.57"(1132mm)	Surface
LN1-SF-8-(B/W)	89.13"(2264mm)	Surface
LN1-PD-4-(B/W)	44.57"(1132mm)	Pendant
LN1-PD-8-(B/W)	89.13"(2264mm)	Pendant

(B/W) - Select B (black) or W (white) at the end of each code for finish option.

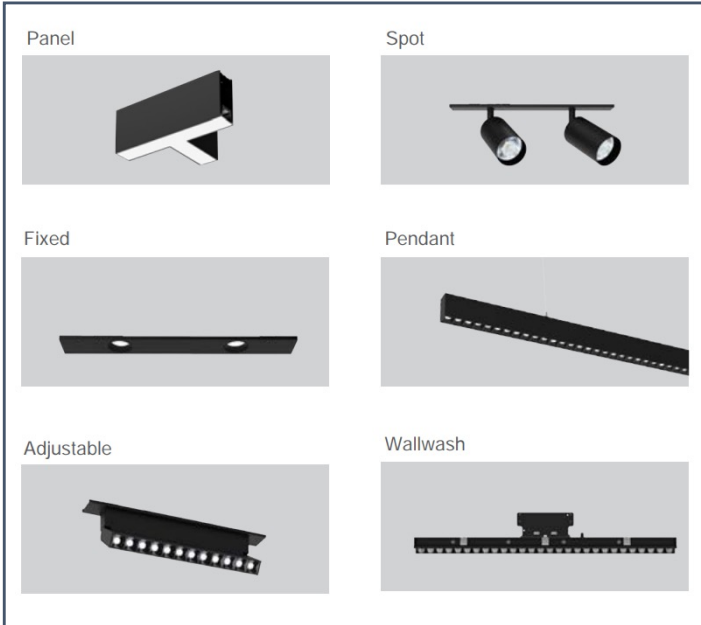
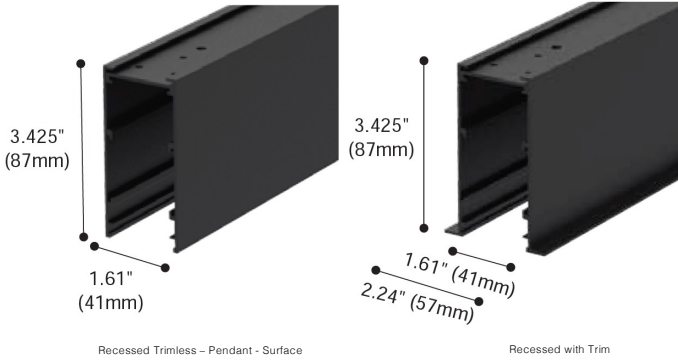

Availability of Modules to Install with Linea 1 - Spec Sheets available

Accessories

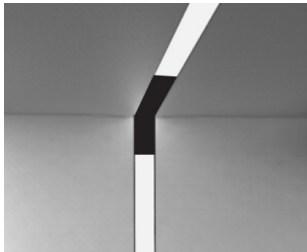

Product: LN1-VC

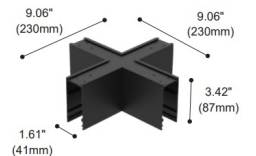
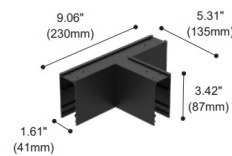
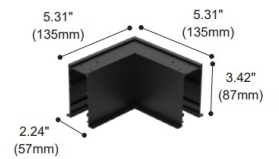
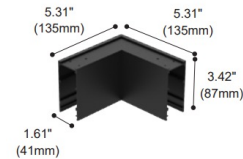
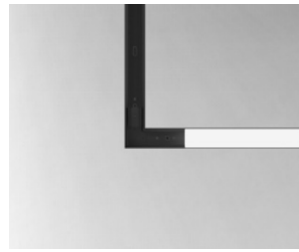
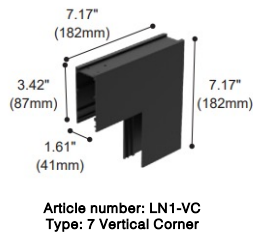

LINEA 1- TRACK

V2.8

ACCESSORIES

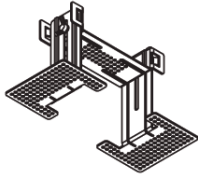

2 PCS

LN1-TB-1
Type: Trimless bracket

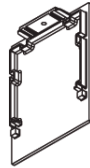

2 PCS

LN1-EC-1
Type: End cap

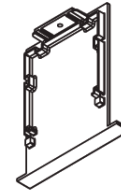

2 PCS

LN1-TEC-1 Type:
Trim end cap

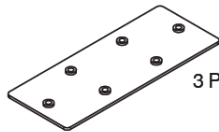

3 PCS

LN1-SM-PR
Type: Surface mounted &
Pendant reinforced plate

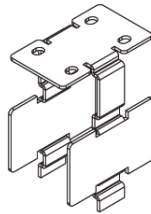

LN1-LA-ER
Type: Light Leak-proof aluminum
extrusion reinforce plate

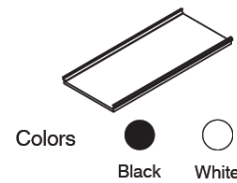

Colors



LN1-BC-11 11.14"(283mm)
LNA1-BC-22 22.28"(566mm) Type: Blank cover

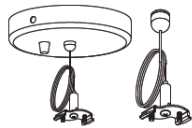

LN-15
Type: Pendant Kit
for power connection
(without power cord)

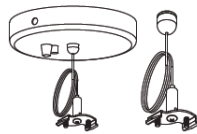

LN-15-V
Type: Pendant Kit
for power connection
(without power cord
and signal wire)



LN-PK
Type: Pendant kit



LN-PCC
Type: Power cord
connector



LN-PCA-180 71"(1800mm)
Type : Power cord connect to AC



LN-PCM-30 12"(300mm)
LN-PCM-60 24"(600mm)
Type : Power cord connect
between modules

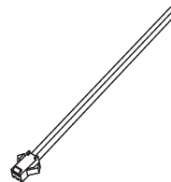

LN-SWCD-180 71"(1800mm)
Type : Signal wire connect
to system / dimmer

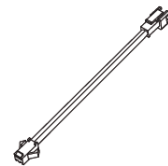

LN-SWCM-30 12"(300mm)
LN-SWCM-60 24"(600mm)
Type : Signal wire connect
between modules