

## LUZ 5 – ROUND

Fixture Type: \_\_\_\_\_

Type: \_\_\_\_\_

Project: \_\_\_\_\_

Location: \_\_\_\_\_

V2.8



### TECHNICAL SPECIFICATION

Minimum profile downlight with metal conduit and driver included for easy remodel or new construction installation.

### SPECIFICATIONS

- Construction: Die-cast Aluminum
- Optics: PMMA Lens
- Power: 45W Input: 120-277 VAC, 50/60Hz
- CCT: 2700K, 3000K, 3500K, 4000K
- CRI: +90
- LED Source: 1961lm-3305lm
- Beam Angle: 20°/40°/55°
- Adjustable fixture from 0° -30° Tilt – Rotation 0°-358°
- Dimming Options: DALI – TRIAC – 0-10V
- Light Source: Integrated LED Lens: TIR lens
- Rated Life: L80 >50000 Hours
- Finish: Electrostatically Powder Coated: White, Black, Hazel and Gold (RAL options available).
- Standards: ETL, cETL, Wet and Damp Location Listed
- Fixed and Wall wash – Wet Location Rated
- Adjustable - Damp Location Rated

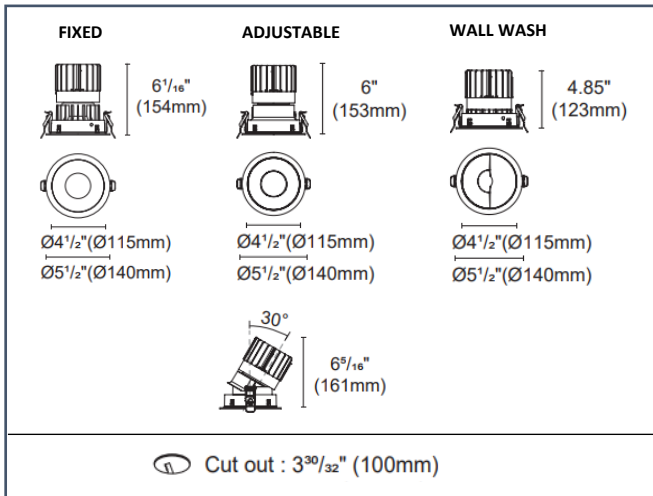

### FINISHES

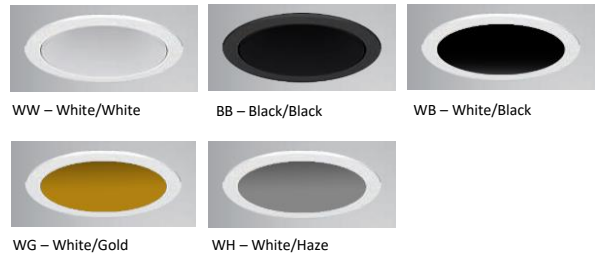

### OPTICS

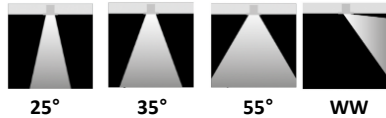

### CCT

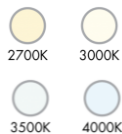

### 1. Trim Type

- LUZ5-RFT** = Round Reflector, Fixed, Trim (3305lm) **Wet**
- LUZ5-RAT** = Round Reflector, Adjustable, Trim (3190lm) **Damp**
- LUZ5-RWWT** = Round Reflector, Wall Wash, Trim (1961lm) **Wet**

### 2. Color Temperature

- 27** = 2700K  
**30** = 3000K  
**35** = 3500K  
**40** = 4000K

### 3. Optic

- N** = 25°\*  
**M** = 35°\*  
**W** = 55°\*  
**WW** = Wall Wash\*\*

### 5. Finish

- WW** = White Trim / White Reflector  
**BB** = Black Trim / Black Reflector  
**WB** = White Trim / Black Reflector  
**WG** = White Trim / Gold Reflector  
**WH** = White Trim / Haze Reflector

### 6. Dimming

Please see **Housing Ordering Sheet (page 2)**

### Accessories



\* Not available for LUZ5-RWWT

\*\* Only available optic for LUZ5-RWWT

\*\*\* Only available for Damp Locations

Example: **LUZ5-RFT-30-M-WW** = 5" Round Fixed Downlight – 3000K – 40° Optic – White Trim / White Reflector

## LUZ 5 – ROUND

V2.8

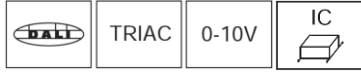

New Construction

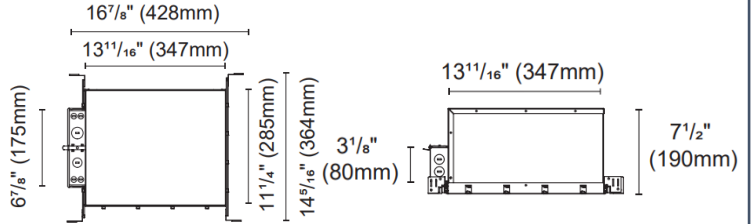

### LZNIC-45

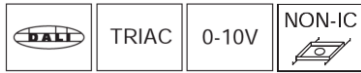

Remodel

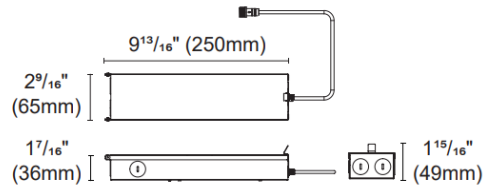

Internal space dimension:  
L 9 13/16" (250mm) X W 2 1/2" (64mm) X H 1 5/16" (34mm)

### LZREM-45



New Construction Plate

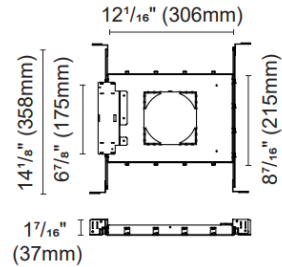

### LZNCP-5

#### 1. Trim Type

**LCNCP-45** = New Construction Housing – IC Rated

**LZREM-45** = Remodel Housing (non IC)

**LZNCP-5** = New Construction Plate (non IC)

#### 2. CONTROL

**TRIAC** = TRIAC (120V)  
**0-10V** = 0-10V (120-277V)  
**DALI** = DALI (120-277V)

#### 5. OPTIONS

**EMB** = Emergency Battery Holder / Battery Not Included



EMB – Emergency holder.

Example: **LCNCP-45-TRIAC** = New Construction Housing – Triac Dimming